

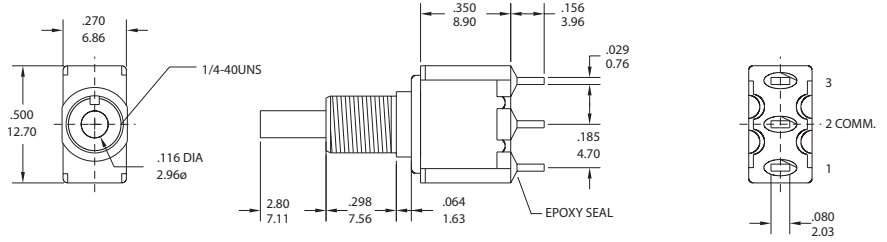

### SPDT

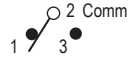

| Model No.   | Switching position |     |
|-------------|--------------------|-----|
| L8601       | on                 | on  |
| L8603       | on                 | mom |
| Term. Comm. | 2-3                | 2-1 |



L8601-EBR-E

### SPDT



| Model No.   | Switching position |     |
|-------------|--------------------|-----|
| L8601P      | on                 | on  |
| L8603P      | on                 | mom |
| Term. Comm. | 2-3                | 2-1 |

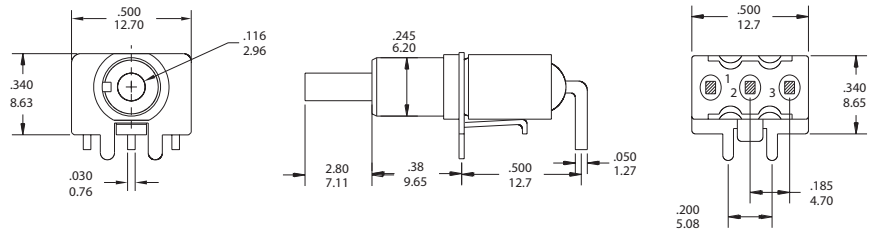

L8601P-MR-E

### SPDT



| Model No.   | Switching position |     |
|-------------|--------------------|-----|
| L8601L      | on                 | on  |
| L8603L      | on                 | mom |
| Term. Comm. | 2-3                | 2-1 |

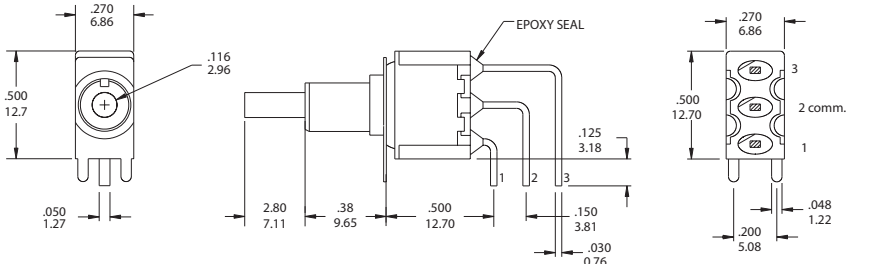

L8601L-MR-E

### DPDT



| Model No.   | Switching position |              |
|-------------|--------------------|--------------|
| L8602       | on                 | on           |
| Term. Comm. | 2-3 □<br>5-6       | 2-1 □<br>5-4 |

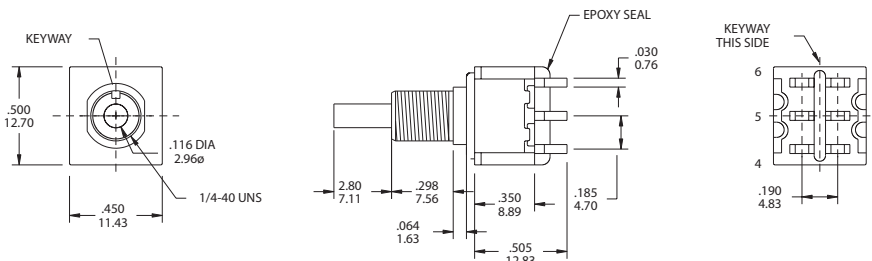

L8602-EBR-E

### DPDT



| Model No.   | Switching position |              |
|-------------|--------------------|--------------|
| L8602P      | on                 | on           |
| Term. Comm. | 2-3 □<br>5-6       | 2-1 □<br>5-4 |

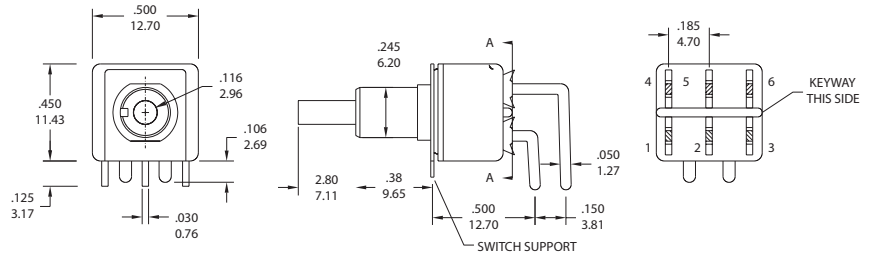

L8602P-MR-E

### DPDT



| Model No.   | Switching position |              |
|-------------|--------------------|--------------|
| L8602L      | on                 | on           |
| Term. Comm. | 2-3 □<br>5-6       | 2-1 □<br>5-4 |

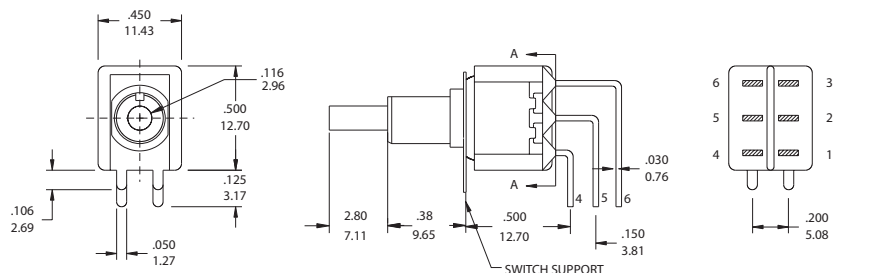

L8602L-MR-E

## Cap and Actuator Option

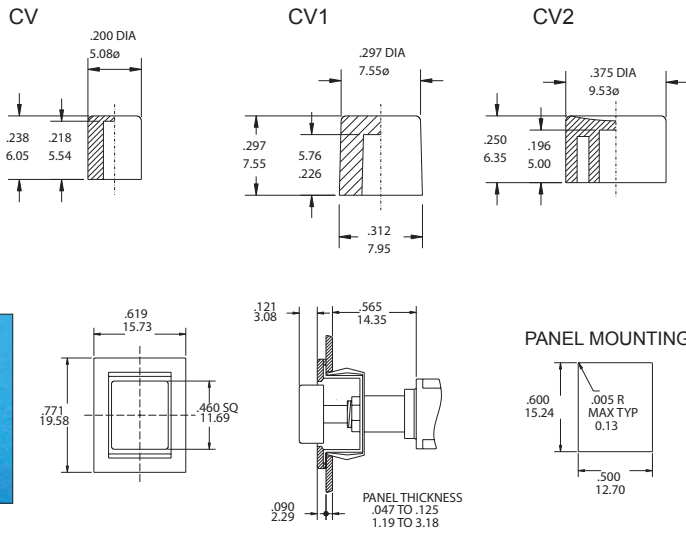

F22A

L860X-F22A-X-BR-E

## Cap color option

| CAP & ACTUATOR OPTIONS |             |
|------------------------|-------------|
| 1                      | White       |
| 2                      | Black(Std.) |
| 3                      | Red         |
| 4                      | Orange      |
| 5                      | Yellow      |
| 6                      | Green       |
| 7                      | Blue        |
| 8                      | Brown       |
| 9                      | Gray        |

## Plunger Option

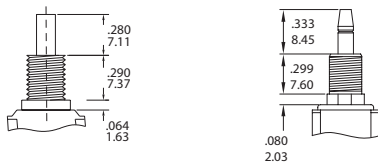

(none) STD.

M

Plunger material:  
Glass filled nylon or  
glass filled polyester.

Plunger material:  
Brass, chrome plated.

SLIDE

## Bushing Option

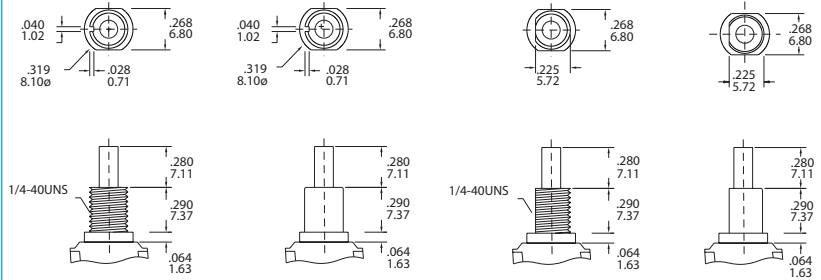

E

M

F

N

## PANEL MOUNTING DIMENSION

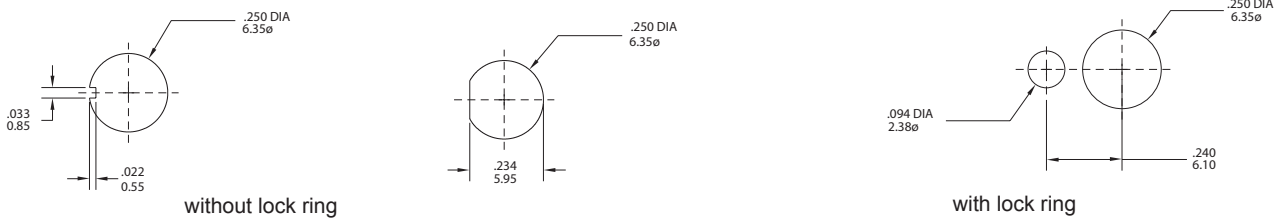

without lock ring

with lock ring

## TERMINAL OPTION (ONLY FOR THE STRAIGHT TYPE L8601~L8602)

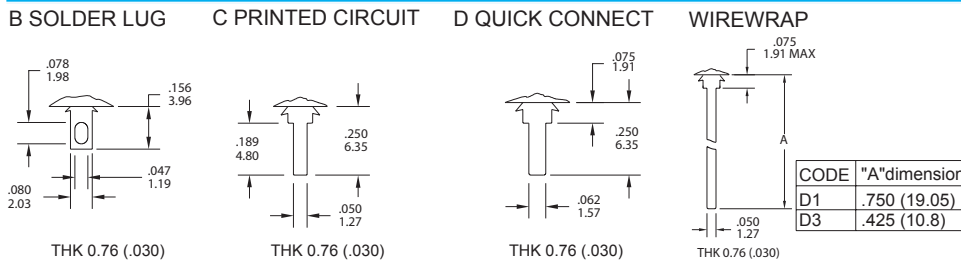

## TERMINAL SEAL OPTION

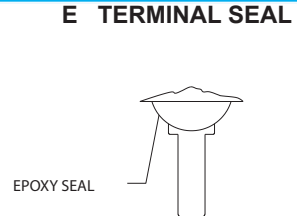

EPOXY SEAL

## CONTACT MATERIAL OPTIONS

| CODE | CONTACT MATERIAL               | TERMINAL MATERIAL              | RATING   |
|------|--------------------------------|--------------------------------|--|
| Q    | Silver plated                  | Silver plated                  | 5A @ 125VAC or 28 VDC                                  |
| R    | Gold plated over nickel plated | Gold plated over nickel plated | 0.4 VA MAX @ 20VAC or DC MAX                           |
| G    | Gold plated over silver plated | Gold plated over silver plated | 0.4 VA MAX @ 20 VAC or DC MAX or 5A @ 125VAC or 28 VDC |

### VERTICAL SUPPORT BRACKET OPTION

( only apply the straight type terminal . Please choose the terminal option in "c" code)

| option Code | A dimension   |
|-------------|---------------|
| S20/V20     | .460<br>11.68 |
| S25/V25     | .630<br>16.00 |

V20/V25: the snap-in type

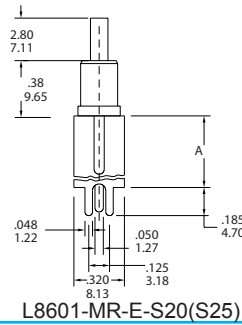
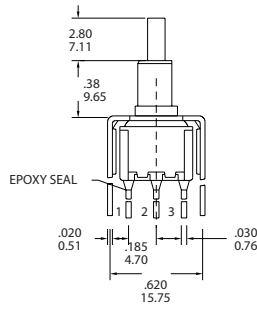

P.C. MOUNTING

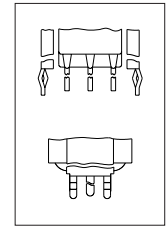
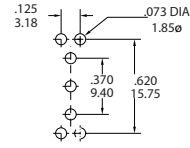

SNAP-IN  
V20/ V25

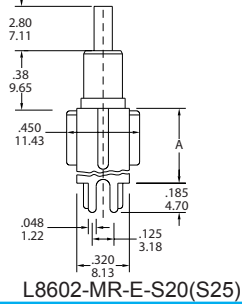
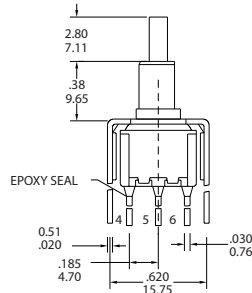

P.C. MOUNTING

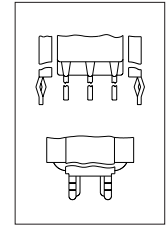
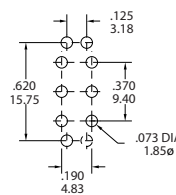

SNAP-IN  
V20/ V25

| option Code | A dimension   |
|-------------|---------------|
| S35/V35     | .460<br>11.68 |
| S40/V40     | .630<br>16.00 |

V35/V40 : the snap-in type

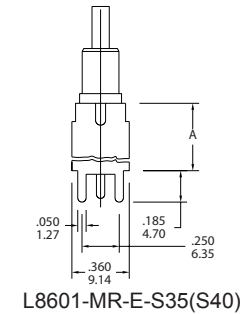
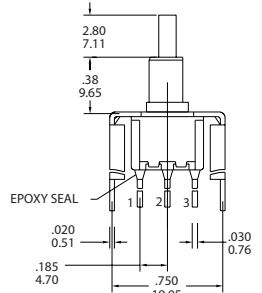

P.C. MOUNTING

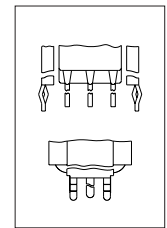
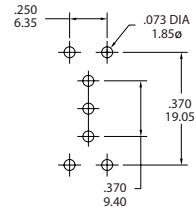

SNAP-IN  
V35/ V40

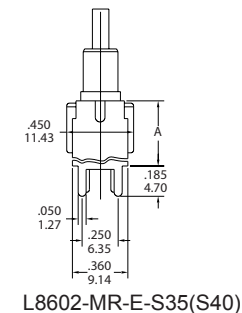
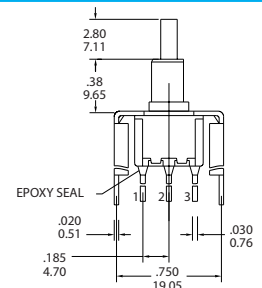

P.C. MOUNTING

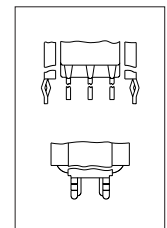
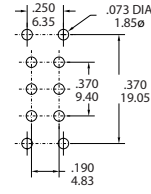

SNAP-IN  
V35/ V40

### The P.C.B mounting Dimensions

L8601P

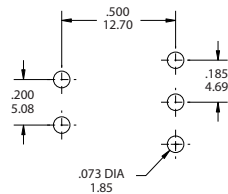

L8602P

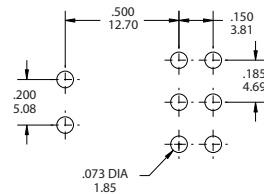

L8601L

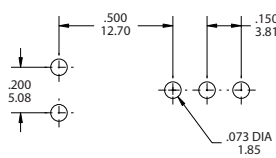

L8602L

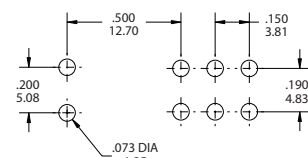

### The hard ware of T80-L push button switches

STD.

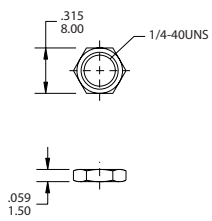

DRESS NUT

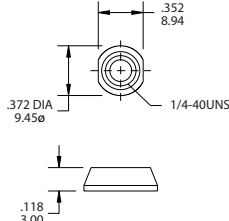

STD.

